



KÄRCHER

K 2.94 M

Operating Instructions

Before first use of the unit
read these operating
instructions and act in
accordance with them.

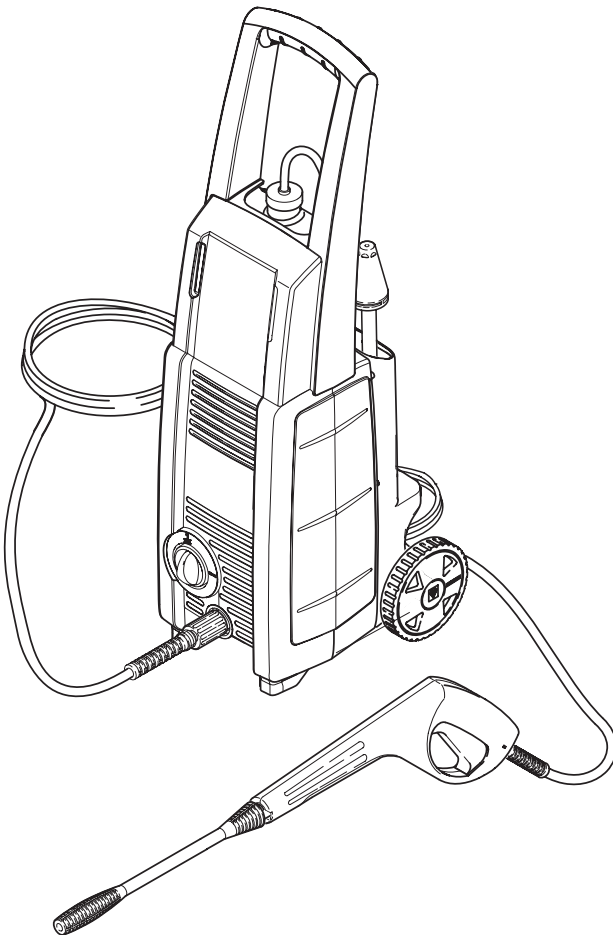

5.961-972.0 (04/07)

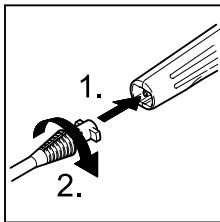
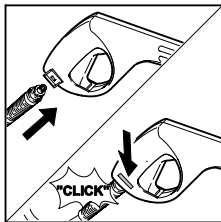
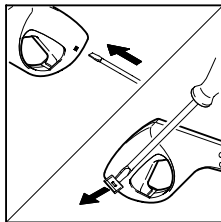
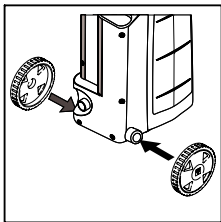
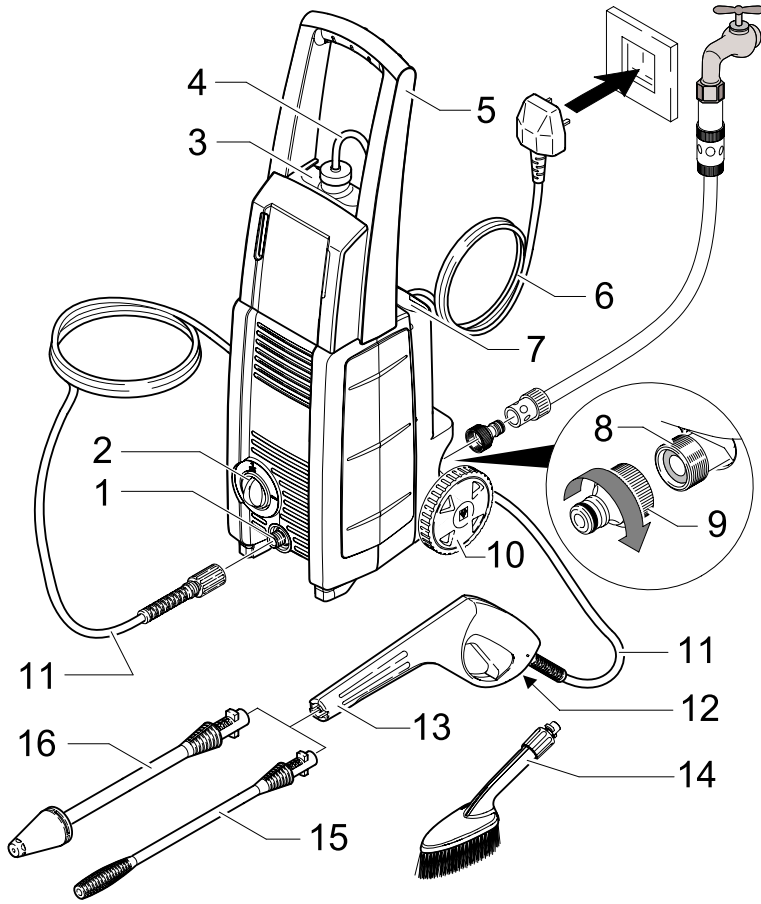
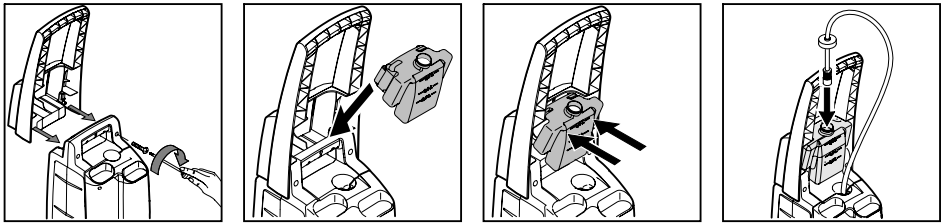

Dear Customer,



Please read and comply with these instructions prior to the initial operation of your appliance. Retain these operating instructions for future reference or for subsequent possessors.

Proper Use

This high-pressure cleaner is designed for domestic use only:

- to clean machines, vehicles, buildings, tools, facades, terraces, garden equipment etc. using a high-pressure water jet (and detergents if required).
- with accessories, replacement parts and detergents approved by Kärcher. Observe the instructions provided with these detergents.

Environmental protection



The packaging material can be recycled. Please do not place the packaging into the ordinary refuse for disposal, but arrange for the proper recycling.



Old appliances contain valuable materials that can be recycled. Please arrange for the proper recycling of old appliances. Please dispose your old appliances using appropriate collection systems

Warranty

The terms of the guarantee applicable in each country have been published by our respective national distributors. We will repair possible faults on your unit free of charge within the warranty period, insofar as the faults are caused by material defects or defective workmanship. Guarantee claims should be addressed to your dealer or the nearest authorized customer service centre, and supported by documentary evidence of purchase.

Description of the Appliance

When unpacking the product, make sure that no accessories are missing and that none of the package contents have been damaged. If you detect any transport damages, please contact your dealer.

Illustrations on Page 2

- 1 High pressure outlet
- 2 ON/OFF switch for appliance
- 3 Detergent tank
- 4 Detergent suction hose with filter
- 5 Transport handle
- 6 Power cord with mains plug
- 7 Accessory compartment
- 8 Inlet water connection (with strainer)
- 9 Hosepipe connector
- 10 Bearing wheel
- 11 High pressure hose
- 12 Safety catch
- 13 Spray gun with built-in low pressure jet
- 14 Washing brush
- 15 Spray lance with high pressure nozzle
- 16 Spray lance with dirt blaster

Safety instructions

⚠ Danger

- Never touch the mains plug and the socket with wet hands.
- The appliance must not be used if the power cable or important parts of the appliance, e.g. safety devices, high-pressure hoses, spray guns, are damaged.
- The appliance may not be used in areas where a risk of explosion is present.
- If the appliance is used in hazardous areas (e.g. filling stations) the corresponding safety provisions must be observed.
- Check the power cord with mains plug for damage before every use. If the power cord is damaged, please arrange immediately for the exchange by an authorized customer service or a skilled electrician.
- High-pressure jets can be dangerous if improperly used. The jet must not be directed at persons, animals, live electrical equipment or at the appliance itself.
- The jet must not be directed at other persons or directed by the user at him/herself to clean clothing or footwear.
- Never use the appliance to clean objects containing hazardous substances (e.g. asbestos).
- Vehicle tyres or tyre valves are susceptible to damage from the high-pressure jet and may burst. The first indication of this is a discolouration of the tyre. Damaged vehicle tyres/tyre valves are highly dangerous. Ensure that a distance of at least 30 cm is observed when cleaning with the jet!
- Never draw in fluids containing solvents or undiluted acids and solvents! This includes petrol, paint thinner and heating oil. The spray mist thus generated is highly inflammable, explosive and poisonous. Do not use acetone, undiluted



acids and solvents as they are aggressive towards the materials from which the appliance is made.

⚠ Warning

- Check the high-pressure hose for damage before every use. Please arrange for the immediate exchange of a damaged high-pressure hose.
- High-pressure hoses, fixtures and couplings are important for the safety of the appliance. Only use high-pressure hoses, fixtures and couplings recommended by the manufacturer.
- Do not use the appliance when there are other persons around unless they are also wearing safety gear.
- Unsuitable extension cables can be hazardous. Only use extension cables outdoors which have been approved for this purpose and labelled with a sufficient cable cross section:
1 - 10 m: 1,5 mm²; 10 - 30 m: 2,5 mm²

Note

- The appliance must not be operated by children or persons who have not been instructed accordingly.
- The operator must use the appliance properly. When working with the appliance, he must consider the local conditions and pay due care and attention to other persons, in particular children, who are nearby.
- Observe a distance of at least 30 cm when using the jet to clean painted surfaces to avoid damaging paintwork.
- Cleaning operations which produce oily waste water, e.g. engine washes, underbody washes, may only be carried out using washing stations equipped with an oil separator.
- Wear protective clothing and safety goggles to protect against back spray containing water or dirt.
- Never leave the appliance unattended when it is in operation.
- Make sure that the power cable or extension cables are not damaged by run-

ning over, pinching, dragging or similar. Protect the power cable from heat, oil, and sharp edges.

- *The connection between the power cable and extension cable must not lie in water.*
- *All current-conducting parts in the working area must be protected against jet water.*
- *The appliance may only be connected to an electrical supply which has been installed in accordance with IEC 60364.*
- *The appliance may only be connected to alternating current. The voltage must correspond with the type plate on the appliance.*
- *The minimum fuse rating required at the socket outlet is 13 A (slow-blow).*
- *To avoid accidents due to electrical faults we recommend the use of sockets with a line-side current-limiting circuit breaker (max. 30 mA nominal tripping current).*
- *The plug and coupling of the extension cable used must be watertight.*
- *Always fully unroll electrical cables from the cable drum.*
- *This appliance was designed to be used with detergents which are supplied or recommended by the manufacturer. The use of other detergents or chemicals may compromise the safety of the appliance.*

Safety Devices

Safety devices serve to protect the user and must not be rendered inoperational or their functions bypassed.

Power switch

The switch prevents unintended starting of the appliance. Stop the appliance during breaks or after operation.

Safety catch

The safety catch on the trigger gun prevents the appliance from being switched on unintentionally.

High pressure hose

The high pressure hose is specially constructed with reinforced walls to handle water pressure up to 11 MPa (1600 psi) - it is easily damaged and should be stored carefully.

- *Do not kink.*
- *Do not drive vehicles over the hose.*
- *Do not expose the hose to sharp edges or corners.*

Misuse will lead to ballooning or premature failure and will invalidate warranty.

Commissioning and operation

Before Startup

- Assemble your high pressure cleaner as shown on page 2.
- Push out the safety clip in the spray gun using e.g. a small screwdriver.
- Join high pressure hose and spray gun together.
- Push clip in until it engages and check that it is securely fastened by pulling on the high pressure hose.

Water supply

The appliance is not suited for use in the drinking water supply network. It is necessary to install a suitable system separator from Kärcher, if the device is to be used in the drinking water supply network.



Water supply from mains

For connection values, see type plate/technical data.

Observe regulations of water supplier.

- Use a fibre-reinforced hose (not included) with a standard coupling:
 - Minimum diameter, 1/2 inches (13 mm)
 - Minimum length, 7.5 m.
- Screw the hosepipe connector (supplied) to the inlet water connection on the appliance.
- Push the water supply hose onto the hosepipe connector, then connect it to the tap.

⚠ Caution

Never operate the high-pressure cleaner when the tap is turned off as dry running will damage the high pressure pump.

If the water supply is not clean, the Kärcher water filter must be used (special accessory - order No. 4.730-059).

Start up

- Screw high pressure hose on to high pressure outlet on appliance.
- Push the appropriate spray lance on to the spray gun and fasten it by turning it to the right through 90°.
- Open tap.
- Plug in mains plug.
- Set main switch to "I/ON".
- Press safety catch on the spray gun to release it and pull lever.

High pressure operation

⚠ Risk of injury

The spray gun is subjected to a recoil force when the water jet is discharged. Make sure that you have a firm footing and are also holding the spray gun and spray lance firmly.

Spray lance with high pressure nozzle

For normal cleaning tasks.

Spray lance with dirt blaster

For strong contaminations.

Operation with detergent

Note: Detergent can only be added when the appliance is being operated in low pressure mode.

All washing brushes supplied by Kärcher are designed for use with detergents.

→ Detach spray lance from spray gun.

Note: A low-pressure jet is generated if the spray lance is not attached to the spray gun.

Detergent infeed from detergent tank

- Fill the detergent tank with detergent tablet and water or detergent concentrate and water (Observe metering recommendations on the packaging label of the detergent.)
- During low pressure operation, detergent is automatically drawn in from the filled detergent tank.

Recommended Cleaning Method

- 1 Spray a small dose of the detergent on the dry surface, and allow it to react (make sure the detergent does not dry up).
- 2 Wash off the loosened dirt using the high-pressure jet.

Detergents

To ensure a trouble-free operation of the appliance and to match the individual cleaning task, we recommend our Kärcher detergent and maintenance agents. Please ask for our advice, or request information on the products.

Interrupting operation

- Release the lever on the spray gun.
- During breaks, use the safety catch to secure the spray gun lever.
- During longer breaks (more than 5 minutes), also turn the appliance off using the ON/OFF switch.

Finish operation

- Release the lever on the spray gun.
- Switch the appliance switch to "0/OFF".
- Turn off tap.
- Press the lever on the spray gun to release any remaining pressure in the system.
- Disconnect the appliance from the water supply.
- Detach spray lance from the spray gun.
- Briefly switch the appliance on ("1/ON"), press the spray gun lever until no further water is discharged (approx. 1 min).
- Switch the appliance switch to "0/OFF".
- Use the safety catch to secure the spray gun lever.
- Pull out the mains plug.
- Roll up the power cord and loop it e.g. round the handle.

Storing the Appliance

- Store the spray gun and the spray lances in the accessory compartment.

⚠ Caution

Please remove the detergent from the detergent tank if the application is transported in a reclined position.

⚠ Risk of frost

Protect the appliance and accessories against frost.

The appliance and its accessories can get destroyed through frost if there are any water residues in them. To avoid damage to them:

- Store the appliance and the entire accessories in a frost-safe room.

Troubleshooting

You can rectify many faults yourself with the help of the following overview.

If in doubt, please consult the authorized customer service.

⚠ Risk of electric shock

Always switch off the appliance and pull out the mains plug before care and maintenance work.

⚠ Warning

Repair works may only be performed by the authorized customer service.

Appliance does not start

- Check whether the voltage indicated on the type plate corresponds to the voltage of the socket.
- Check the power cable for damage.

Pressure does not build up in the appliance

- Evacuate air from the appliance: Switch on the appliance when the high pressure hose is not connected and allow it to run until the water which discharges from the high pressure outlet is free of bubbles. Then connect the high pressure hose again.
- Clean the filter in the water supply connection: This can be easily removed using flat-nose pliers.
- Check all supply lines to the high pressure pump for leaks or blockages.

Strong pressure fluctuations

- Clean the high-pressure nozzle: Remove dirt and debris from the nozzle bore with a needle and rinse through with water towards the front.
- Check the volume of incoming water.

High pressure pump leaking

- Slight leakage from the high pressure pump is normal. If the leakage increases contact the authorized customer service.

No detergent infeed

- Detach the spray lance from the trigger gun and work without the spray lance.
- Clean the filter of the detergent suction hose.
- Check the detergent suction hose for kinks.

Maintenance and Care

⚠ Risk of electric shock

Always switch off the appliance and pull out the mains plug before care and maintenance work.

Cleaning

Prior to longer periods of storage, e.g. in the winter:

- ➔ Remove filter from suction hose for detergent and clean with running water.
- ➔ Pull out filter in water connection using flat-nose pliers and clean with running water.

Maintenance

The appliance is maintenance-free.

Spare Parts

Only use original Kärcher spare parts. You will find a list of spare parts at the end of this document.

Special accessories

Special accessories expand the possibilities of using your appliance. Please contact your Kärcher dealer for further information.

Specifications

Power connection

Voltage (1~50 Hz)	230-240 V
Connected load	1,4 kW
Mains fuse (slow-blow)	13 A
Protective class	I
Protection class	IP X5

Water connection

Max. feed temperature	40 °C
Min. feed volume	8 l/min
Feed pressure	0,2-1,2 MPa

Performance data

Working pressure	8 MPa
Max. permissible pressure	10 MPa
Water flow rate	5,5 l/min
Detergent flow rate	0,4 l/min
Recoil force of spray gun	12 N
Hand-transmitted vibration (ISO 5349)	0,8 m/s ²
Sound pressure level L _{pA} (EN60704-1)	69 dB(A)
Sound power level L _{WA} (2000/14/EG)	83 dB(A)

Dimensions

Length	251 mm
Width	285 mm
Height	800 mm
Weight	8,4 kg

CE declaration

We hereby declare that the machine described below complies with the relevant basic safety and health requirements of the EU Directives, both in its basic design and construction as well as in the version put into circulation by us. This declaration shall cease to be valid if the machine is modified without our prior approval.

Product: High-pressure cleaner

Type: 1.400-xxx

Relevant EU Directives

98/37/EC

2006/95/EC

89/336/EEC (+91/263/EEC, 92/31/EEC,

93/68/EEC)

2000/14/EC

Applied harmonized standards

EN 60335-1

EN 60335-2-79

EN 55014-1: 2000 + A1: 2001 + A2: 2002

EN 55014-2: 1997 + A1: 2001

EN 61000-3-2: 2000 + A2: 2005

EN 61000-3-3: 1995 + A1: 2001

Applied conformity evaluation method

Appendix V

Sound power level dB(A)

Measured: 81 dB(A)

Guaranteed: 83 dB(A)

The undersigned act on behalf and under the power of attorney of the company management.

H. Jenner

S. Reiser

Alfred Kärcher GmbH Co. KG

Alfred Kärcher-Str. 28 - 40

D - 71364 Winnenden

Phone: +49 7195 14-0

Fax: +49 7195 14-2212

Help-Line

Kärcher (UK) Limited operate a help-line allowing customers to discuss any problems experienced with our products.

The help-line operates during normal business hours, if you have difficulty getting through, please understand that there are peak periods during the day when our consultants are unable to take all calls coming in. In these circumstances we would ask that you try to contact us again later in the day.

The help-line number is 0906 6800632

(calls to this number are charged at 25p per minute) from 8.30 am to 5.00 pm Monday - Friday.

It helps us if you have the model number and data plate details to hand before making your call as there are very many different models of Kärcher Pressure Washers in use.

Alternatively you may write or e-mail to the address below:

Kärcher (UK) Limited

Kärcher House

Beaumont Road

Banbury

Oxon, OX16 1TB

FAX: 01295 752030

E-mail:

retail_inquiries@karcheruk.co.uk

Spare Parts

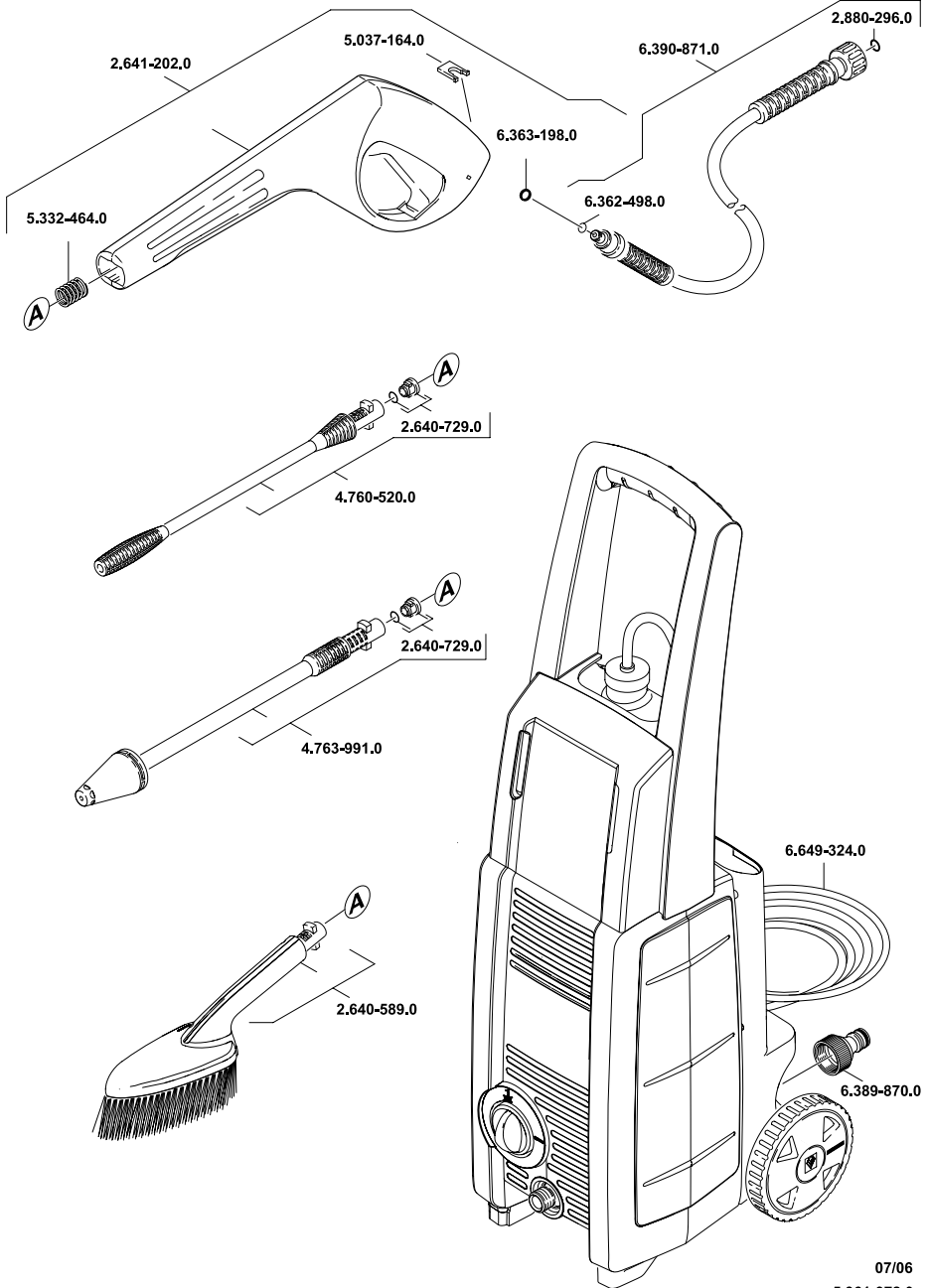

07/06
5.961-972.0



www.karcher.co.uk